

\*Minifix milini elinizle döndürerek çıkarınız.  
\*Remove the minifix shaft by turning it with your finger

## Temizlik ve Bakım Rehberi

### Yeni Mobilyalarınızı

AŞAĞIDA BELİRTİLEN KONUARI DİKKATE ALMANIZ ÜRÜNLERİ DAHA UZUN SÜRE KULLANMANIZA OLANAK SAĞLAYACAKTIR.

Mobilyalarınızı herhangi bir sıvıya maruz bırakmayın. Dökülen sıvıları derhal yumuşak ve hafif nemli bir bezle siliniz. Yüzeyde biriken sıvının üzerine kağıt havlu koyunuz ve kurumaya bırakınız. Herhangi bir lekelenmeyi önleyin. Ürünü temizlerken kimyasal cam temizleyiciler ve sprey cilaları kullanmaktan kaçınınız. Mobilyalarınızı doğrudan güneş ışığına maruz bırakmayın, kalorifer peteği veya klimate yakın olan mobilyalarınızın bulunduğu odayı zaman zaman havalandırınız.

Yoğun güneş ışığı veya aşırı ısıcağa maruz kalma mobilya yüzeyinde solma meydana gelebilir.

Aşırı sıcaklıklar ve nem mobilya yüzeyinin kırılmasına veya çatlamasına neden olabilir.

Ahşap kaplamanın üzerine kauçuk veya plastik malzemeler koymayın. Uzun süre ürün üzerinde bekleyen plastik veya kauçuk içerisindeki kimyasallar, zamanla reaksiyon gösterebilir.

Mobilya yüzeyine sıcak nesnelere koymaktan kaçınınız. Eğer sıcak bir nesne koyacaksınız koruyucu bir parça veya tabak ile sıcaklığın etkisini azaltmanızı öneririz.

Mobilya yüzeyinde biriken tozları nemli ve kuru olmak üzere iki ayrı bez ile temizleyiniz.

Mobilya yüzeyine bırakılan zararlı nesnelere uzun süre beklediğinde ürüne hasar verebilir.

Mobilya üzerinde meydana gelen küçük çizikler, çizik çıkarıcı küçük çubuklar yardımıyla temizlenebilir.

Çizik çıkarıcı çubukları boya malzemeleri satan herhangi firmadan temin edebilirsiniz.

## Cleaning and Care Guide

### Your New Furniture

FOLLOWING THESE FEW BASIC STEPS WILL HELP YOU PROTECT YOUR INVESTMENT FOR YEARS OF ENJOYMENT TO COME.

#### Do not expose your furniture to any liquids.

Wipe up spilled liquids immediately with a soft, slightly damp cloth in the direction of the wood grain.

For stone surfaces , soak liquids up with a paper towel and wipe dry to avoid any staining .

Avoid harsh commercial cleaners, glass cleaners and spray polishes on wood.

#### Do not expose your furniture to strong or direct sunlight, leave near heat outlets or air conditioning units, or open windows and dampness.

Excessive exposure to sunlight and heat can cause your furniture's finish to start fading.

Extreme temperatures and humidity changes can cause wood cracking and splitting.

#### Do not place rubber or plastic materials on the wood finish.

Chemicals within the plastic or rubber may react with the finish if left in contact for a long period of time. Use a strip of felt or cork.

#### Never place hot objects on any furniture surface.

Use a hot plate between your furniture and hot objects to protect the finish.

#### Frequently dust surfaces with a clean, damp, lint free cloth.

Abrasive build up can cause damage a finish over time.

Small scratches and marks can be touched up or covered with a mark or scratch remover or a touch up stick. These can be purchased from any paint or hardware store.



## Frezya Genç Odası Şifonyer

### Montaj Talimatı

Kupa'yı tercih ettiğiniz için teşekkür ederiz.

Ürün kurulumunu eğlenceli hale getirmek için size sunmuş olduğumuz ayrıntılı montaj kılavuzu ile ürünlerinizi rahatlıkla kurabilirsiniz.

Size kolaylık sağlamak için, montaj talimatını mümkün olduğunca basite indirmeye çalıştık. Buna rağmen montaj esnasında herhangi bir aksaklık olursa lütfen tedarikçi firmadan yetkili bir kişi ile temasa geçiniz. Montaj talimatını yerine getirirken listede verilen sıralamaya göre hareket etmeniz kurulumu çabuk ve sorunsuz yapmanıza olanak sağlayacaktır.

Ürün Açıklaması : Frezya Şifonyer  
Model Numarası : 78007  
Boyut : W: 85,5 / D: 47 / H: 82  
Ürün Toplam Ağırlığı : 46,44 kg

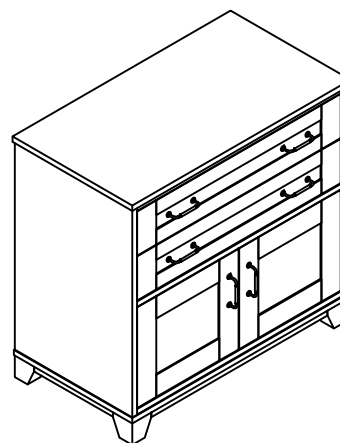

## Frezya Young Room Chest Of Drawers

### Assembly Installatinon

Thank you for purchasing this product from us. We want your whole Kupa experience to be enjoyable, and that includes unpacking and assembling your item.

For your convenience, we've taken care to make these instructions as easy to follow as possible, however, if due to the technical nature of some items you're not absolutely sure, please consult a specialist to avoid breakages or incorrect assembly. Follow step by step instructions carefully and you'll be getting the most from your purchase in no time.

Item Description : Frezya Chest Of Drawers  
Model No : 78007  
Dimension : W: 85,5 / D: 47 / H: 82  
Total Weight of Item : 46,44 kg

Montaj Yapacak Kişi Sayısı : People Required

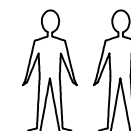

Sadece profesyonel montaj için  
For Professional assembly only

Gerekli Zaman: 40 dak.  
Time Required: 40 min.

Gerekli Aletler

Tools Needed

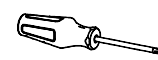
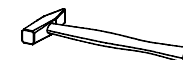

\*Montajı dikey olarak yapınız.  
\*Montaj esnasında zemine zarar vermemek için montaj yapılacak bölgeye mukavva karton seriniz.

\* Vertical Assembly Only.  
\* Please cover floor with Corrugated Board / paper to avoid scratches / damages to floor.

## Montaj Kontrol Listesi

Montaja başlamadan önce aşağıdaki öğelerin hepsine sahip olduğunuzdan emin olunuz.

## Assembly Checklist

Please make sure that you have all of the below items before you start.

## Montaj için verilen aksesuarlar

## Parts supplied for assembly

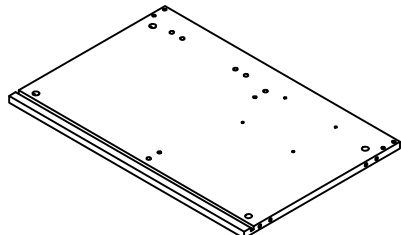

(A1)x1

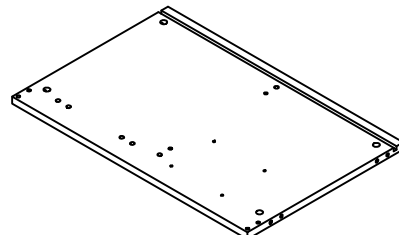

(A2)x1

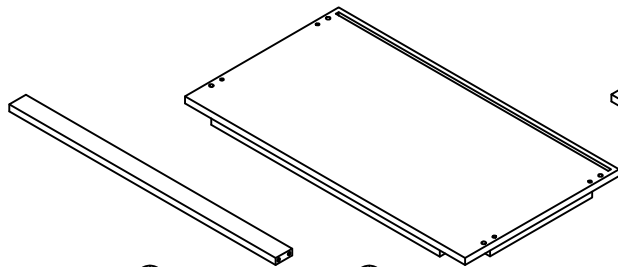

(B)x1

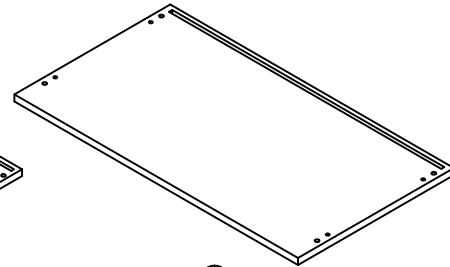

(C)x1

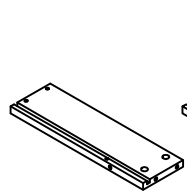

(E)x2

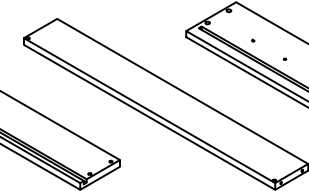

(J1)x2

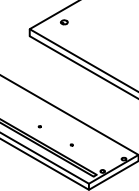

(J2)x2

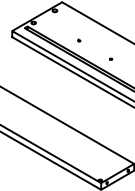

(J3)x2

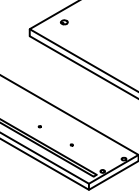

(K)x2

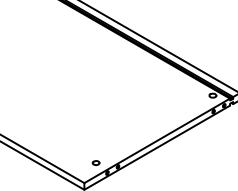

(D)x1

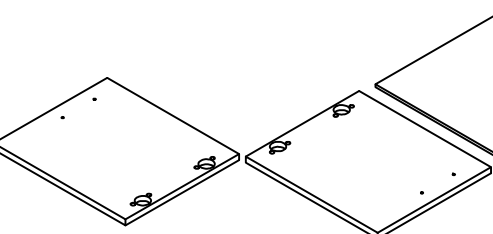

(H)x1

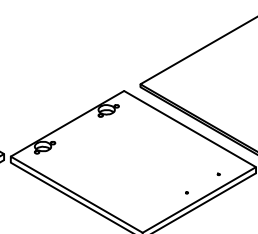

(G)x1

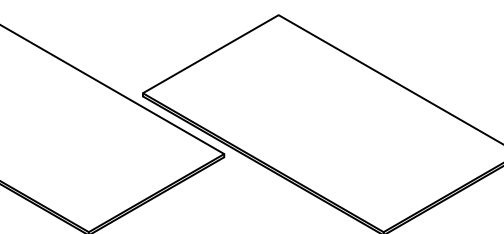

(L)x2

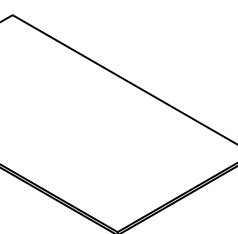

(C)x2

Parça Listesi Part List	A1	A2	B	C	D	E	F	G	H	J1	J2	J3	K	L
Karton Kutu No, Carton Box No.	1	1	1	2	2	1	1	2	2	2	2	2	1	2

## Adım / Step 4

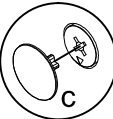
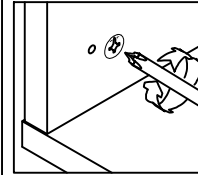
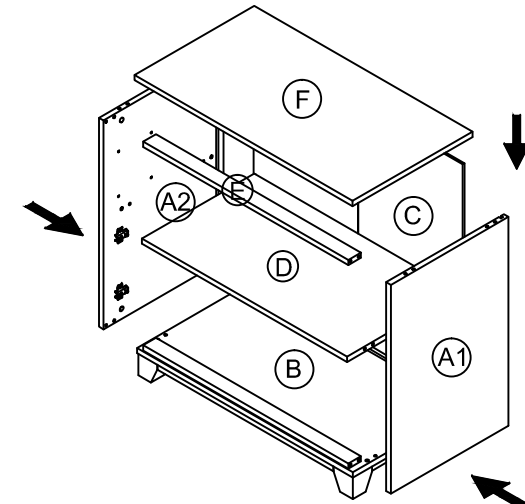

## Adım / Step 5

Önemli !!!  
Çekmeceyi raya yerleştirmeden önce, emniyet piminin açık olduğundan emin olunuz.

Important !!!  
Make sure keep the safety pin open before the drawer is placed.

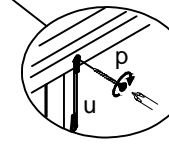
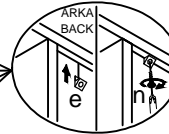
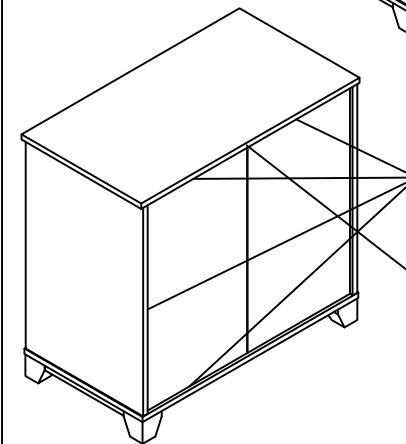
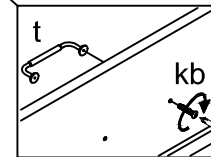
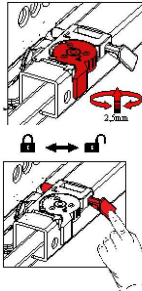
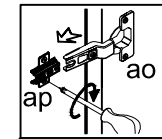
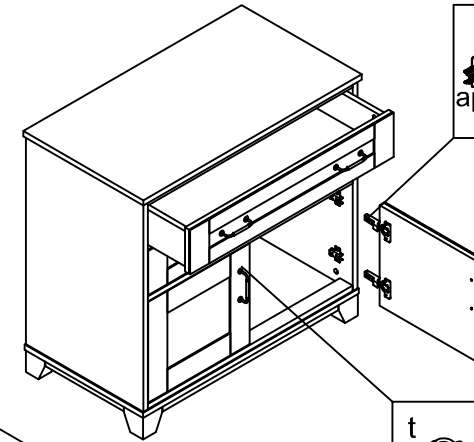

\*Duvar sabitleme halatını yalnız beton duvara bağlanması uygundur. Alçıpan vb. duvarlara uygun değildir. Aksi durumda firmamız sorumlu olamaz.  
\*Fixation rope is just to be fixed on concrete walls. It is not suitable on drywalls, plasterboard walls and etc. In that case our company has no responsibility.

## Adım / Step 3

Parçalar / Parts

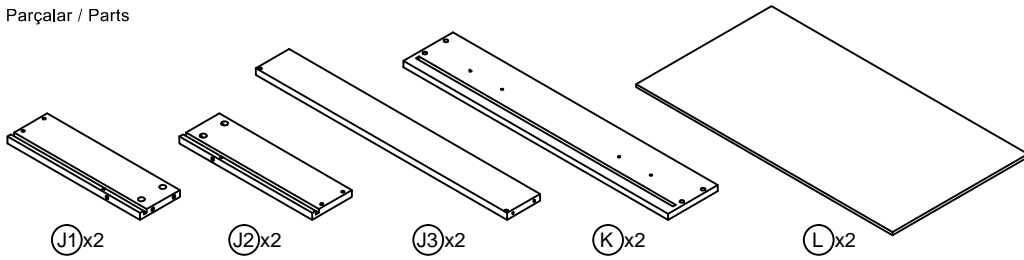

Aksesuarlar / Hardware

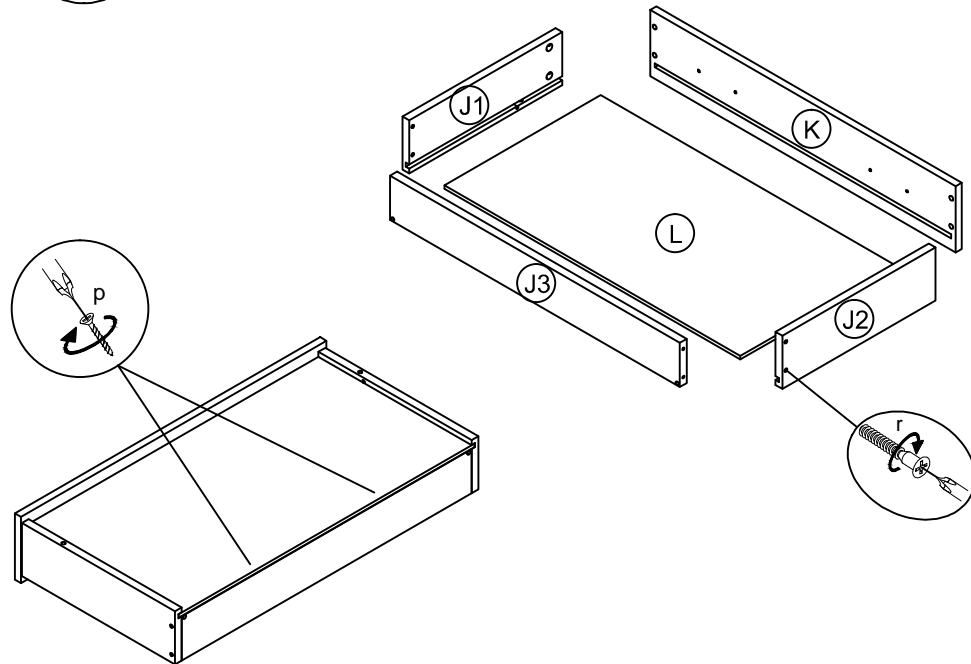
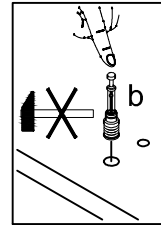
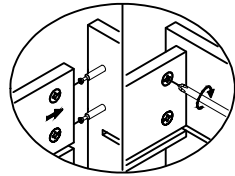
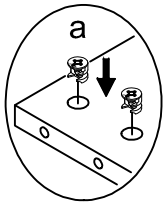
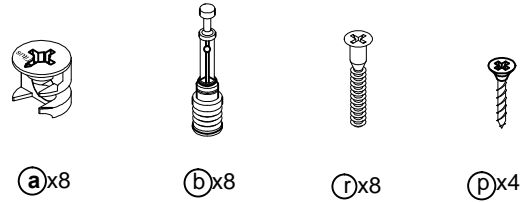

## Montaj için kullanılacak aksesuarlar

## Hardware supplied for assembly

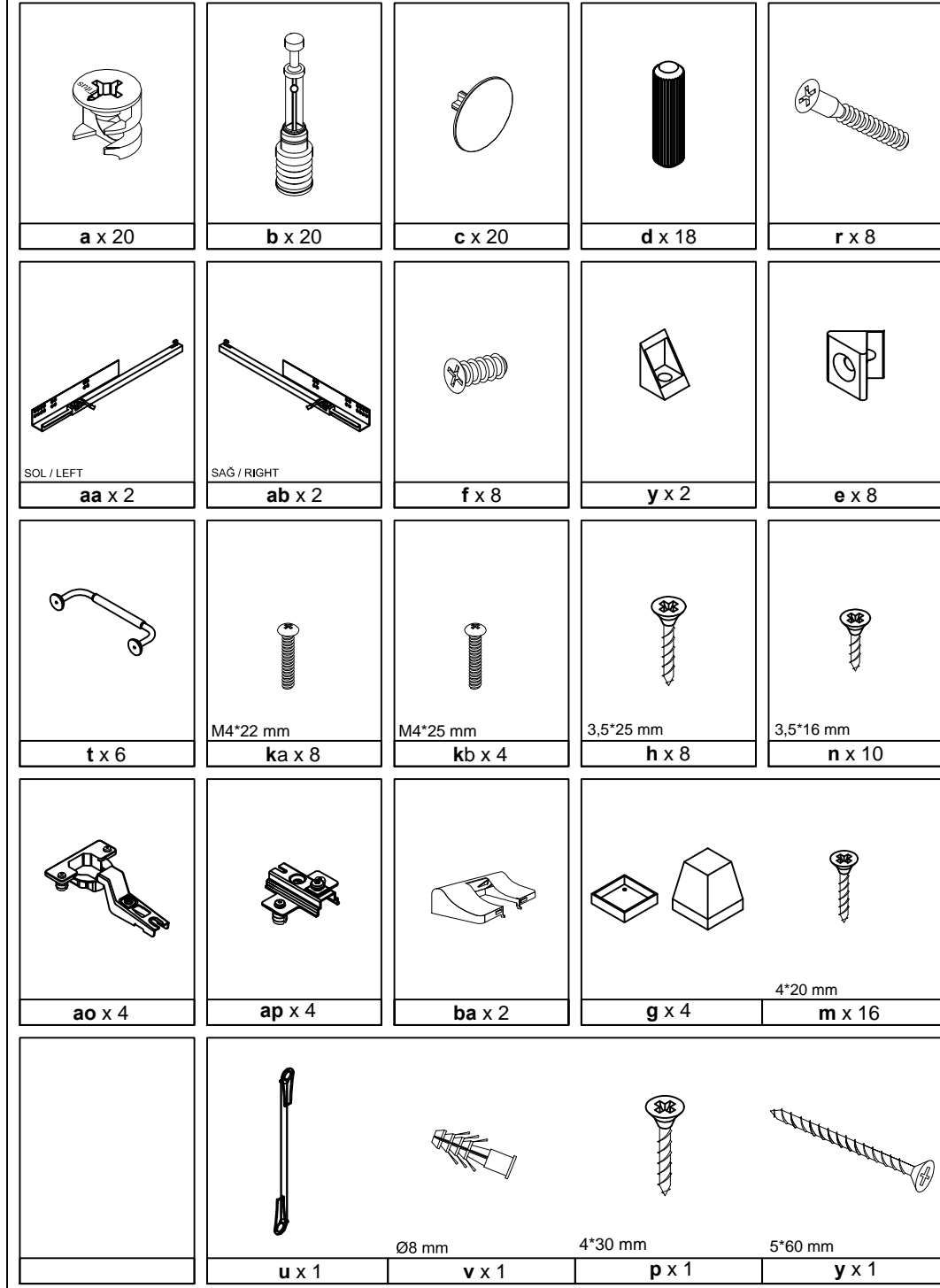

## Adım / Step 1

Parçalar / Parts

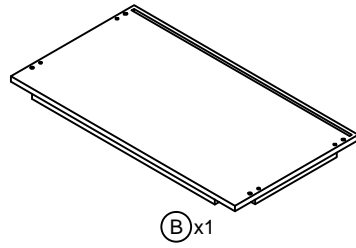

B x1

Aksesuarlar / Hardware



b x4



d x4



m x16

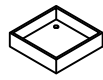

g x4

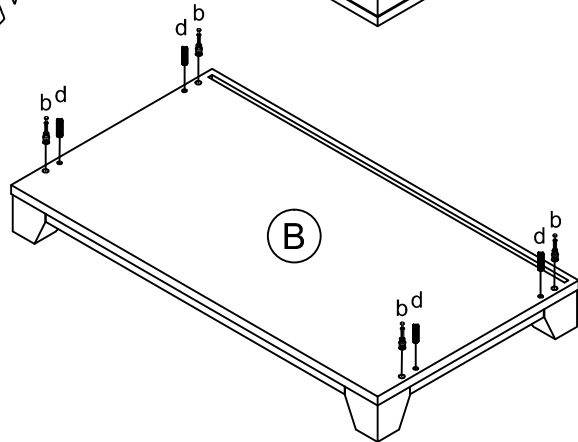
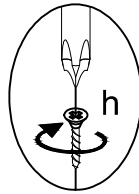
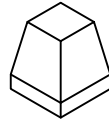

B

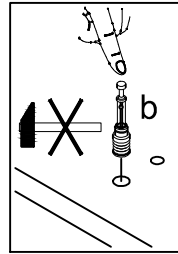

## Adım / Step 2

Parçalar / Parts

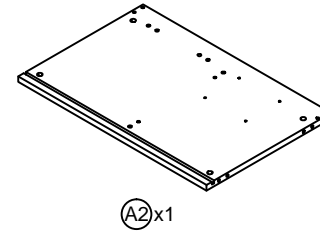

A2 x1

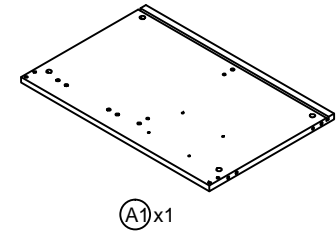

A1 x1

Aksesuarlar / Hardware



b x2



d x10



a x8



f x8

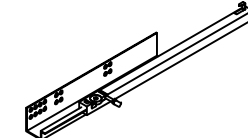

aa x2

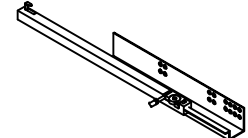

ab x2

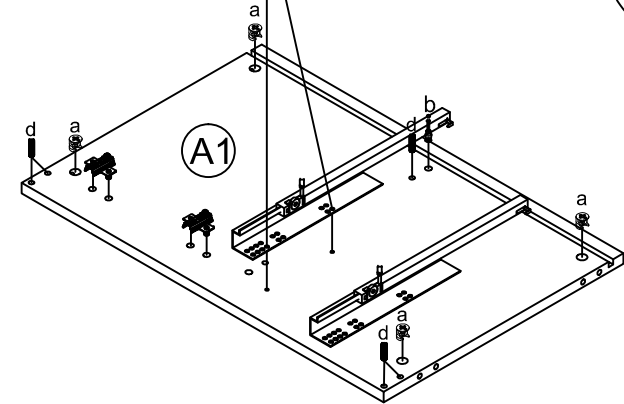
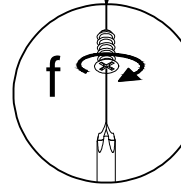
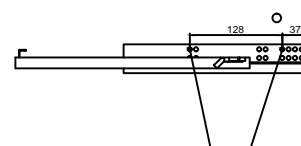
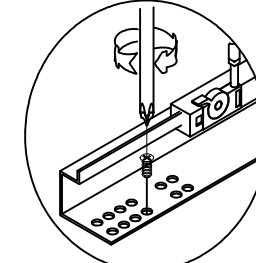
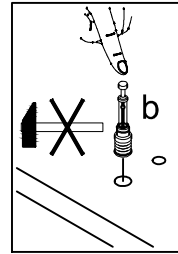

A1

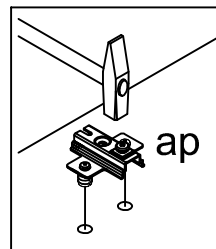

ap