

*Minifix milini elinizle döndürerek çıkarınız.
*Remove the minifix shaft by turning it with your finger



Venüs Genç Odası

5 Kapılı Dolap

Montaj Talimatı

Kupa'yı tercih ettiğiniz için teşekkür ederiz. Ürün kurulumunu eğlenceli hale getirmek için size sunmuş olduğumuz ayrıntılı montaj kılavuzu ile ürünlerinizi rahatlıkla kurabilirsiniz.

Size kolaylık sağlamak için, montaj talimatını mümkün olduğunca basite indirmeye çalıştık. Buna rağmen montaj esnasında herhangi bir aksaklık olursa lütfen tedarikçi firmadan yetkili bir kişi ile temasa geçiniz. Montaj talimatını yerine getirirken listede verilen sıralamaya göre hareket etmeniz kurulumu çabuk ve sorunsuz yapmanıza olanak sağlayacaktır.

Ürün Açıklaması	: Venüs 5 Kapılı Dolap
Model Numarası	: 55005
Boyut	: W: 177,4 / D: 61,6 / H: 205
Ürün Toplam Ağırlığı	: 190,57 kg

Venüs Young Room

5 Doors Wardrobe

Assembly Installatinon

Thank you for purchasing this product from us. We want your whole Kupa experience to be enjoyable, and that includes unpacking and assembling your item.

For your convenience, we've taken care to make these instructions as easy to follow as possible, however, if due to the technical nature of some items you're not absolutely sure, please consult a specialist to avoid breakages or incorrect assembly. Follow step by step instructions carefully and you'll be getting the most from your purchase in no time.

Item Description	: Venüs 5 Doors Wardrobe
Model No	: 55005
Dimension	: W: 177,4 / D: 61,6 / H: 205
Total Weight of Item	: 190,57 kg

Montaj Yapacak Kişi Sayısı : People Required

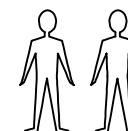

Sadece profesyonel montaj için
For Professional assembly only

Gerekli Zaman: 1 saat 30 dak.
Time Required: 1 hrs. 30 min.

Gerekli Aletler : Tools Needed



*Montajı dikey olarak yapınız.
*Montaj esnasında zemine zarar vermemek için montaj yapılacak bölgeye mukavva karton seriniz.

* Vertical Assembly Only.
* Please cover floor with Corrugated Board / paper to avoid scratches / damages to floor.

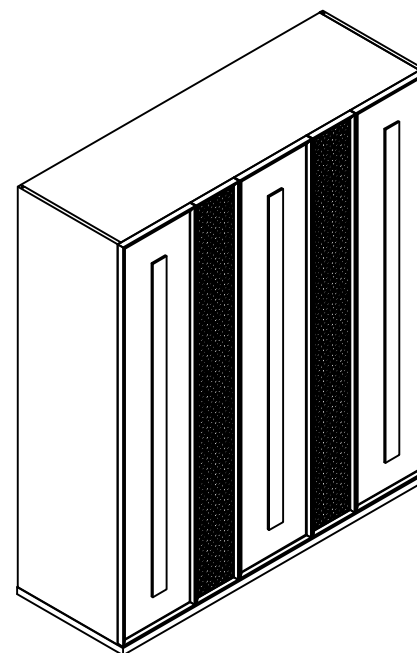

Temizlik ve Bakım Rehberi

Yeni Mobilyalarınızı

AŞAĞIDA BELİRTİLEN KONULARI DİKKATE ALMANIZ ÜRÜNLERİ DAHA UZUN SÜRE KULLANMANIZA OLANAK SAĞLAYACAKTIR.

Mobilyalarınızı herhangi bir sıvıya maruz bırakmayın. Dökülen sıvıları derhal yumuşak ve hafif nemli bir bezle siliniz. Yüzeyde biriken sıvının üzerine kağıt havlu koyunuz ve kurumaya bırakınız. Herhangi bir lekelenmeyi önleyin. Ürünü temizlerken kimyasal cam temizleyiciler ve sprey cıvaları kullanmaktan kaçının. Mobilyalarınızı doğrudan güneş ışığına maruz bırakmayın, kalorifer peteği veya klimateye yakın olan mobilyalarınızın bulunduğu odayı zaman zaman havalandırınız. Yoğun güneş ışığı veya aşırı ısıya maruz kalma mobilya yüzeyinde solma meydana gelebilir. Aşırı sıcaklıklar ve nem mobilya yüzeyinin kırılmasına veya çatlmasına neden olabilir. Ahşap kaplamanın üzerine kauçuk veya plastik malzemeler koymayın. Uzun süre ürün üzerinde bekleyen plastik veya kauçuk içerisindeki kimyasallar, zamanla reaksiyon gösterebilir. Mobilya yüzeyine sıcak nesnelere koymaktan kaçının. Eğer sıcak bir nesne koyacağınız koruyucu bir parça veya tabak ile ısıya maruz etkisini azaltmanızı öneririz. Mobilya yüzeyinde biriken tozları nemli ve kuru olmak üzere iki ayrı bez ile temizleyiniz. Mobilya yüzeyine bırakılan zararlı nesnelere uzun süre beklediğinde ürüne hasar verebilir. Mobilya üzerinde meydana gelen küçük çizikler, çizik çıkarıcı küçük çubuklar yardımıyla temizlenebilir. Çizik çıkarıcı çubukları boya malzemeleri satan herhangi firmadan temin edebilirsiniz.

Cleaning and Care Guide

Your New Furniture

FOLLOWING THESE FEW BASIC STEPS WILL HELP YOU PROTECT YOUR INVESTMENT FOR YEARS OF ENJOYMENT TO COME.

Do not expose your furniture to any liquids.

Wipe up spilled liquids immediately with a soft, slightly damp cloth in the direction of the wood grain. For stone surfaces, soak liquids up with a paper towel and wipe dry to avoid any staining. Avoid harsh commercial cleaners, glass cleaners and spray polishes on wood. **Do not expose your furniture to strong or direct sunlight**, leave near heat outlets or air conditioning units, or open windows and dampness. Excessive exposure to sunlight and heat can cause your furniture's finish to start fading. Extreme temperatures and humidity changes can cause wood cracking and splitting. **Do not place rubber or plastic materials on the wood finish.** Chemicals within the plastic or rubber may react with the finish if left in contact for a long period of time. Use a strip of felt or cork. **Never place hot objects on any furniture surface.** Use a hot plate between your furniture and hot objects to protect the finish. **Frequently dust surfaces with a clean, damp, lint free cloth.** Abrasive build up can cause damage a finish over time. Small scratches and marks can be touched up or covered with a mark or scratch remover or a touch up stick. These can be purchased from any paint or hardware store.

Adım / Step 7

Aksesuarlar / Hardware

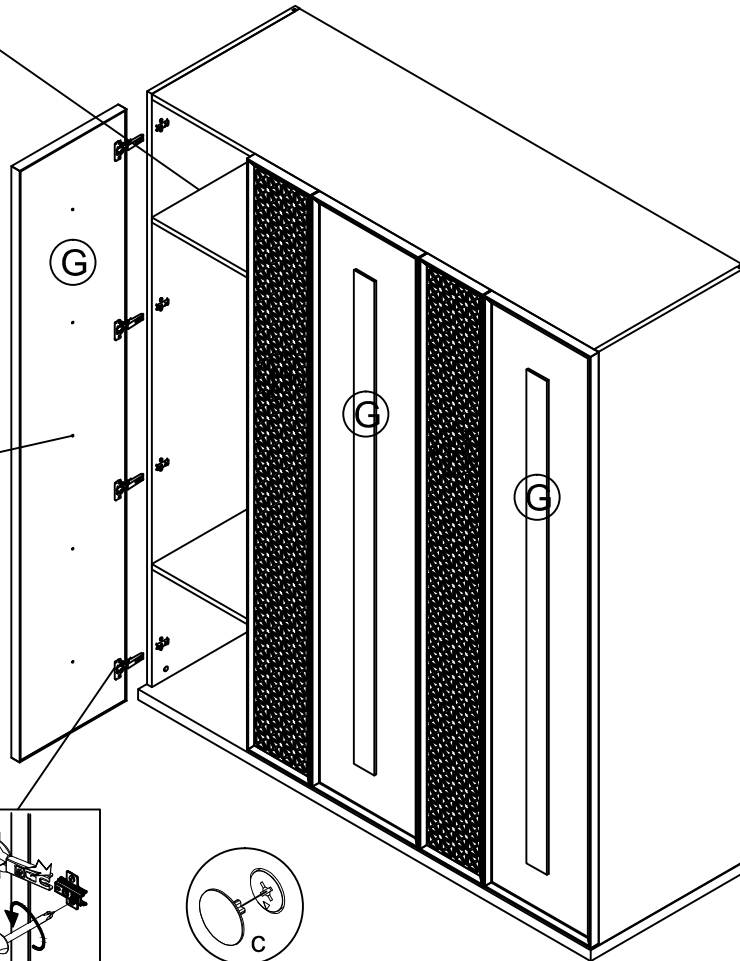
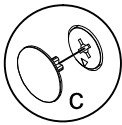
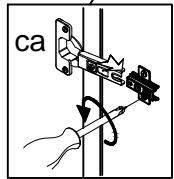
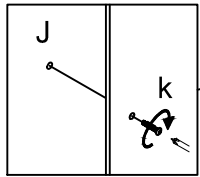
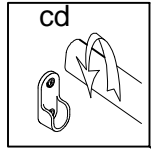
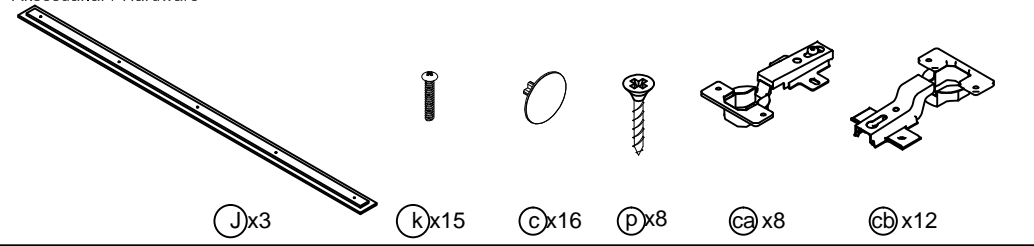

Montaj için kullanılacak aksesuarlar

Adım / Step 1

Parçalar / Parts

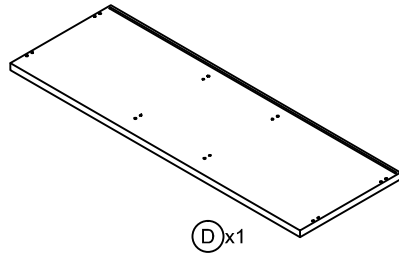

Aksesuarlar / Hardware



(b)x8



(d)x8

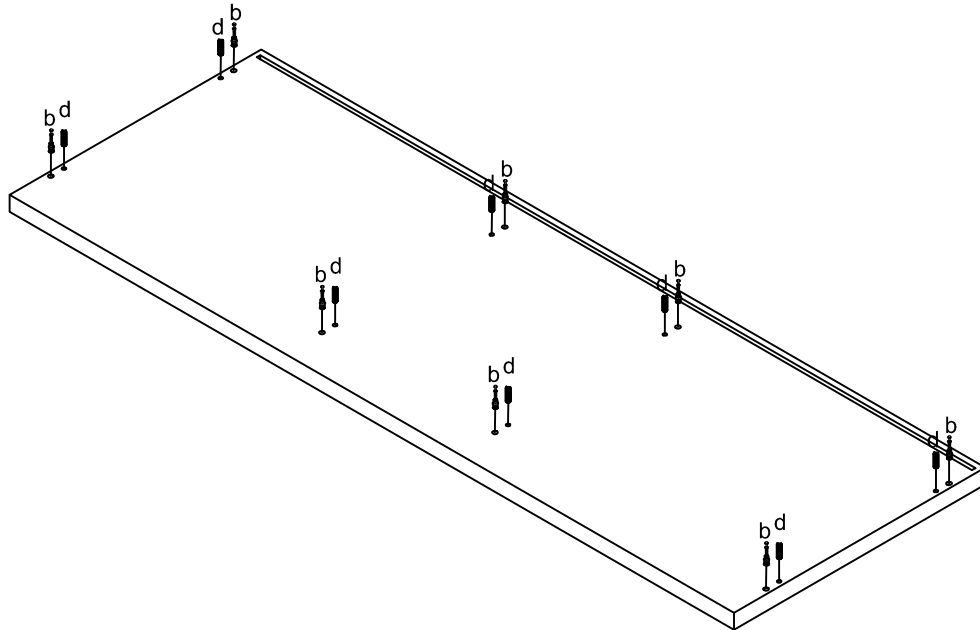
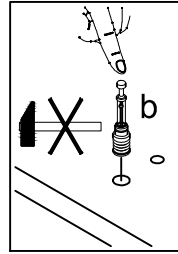

Adım / Step 6

Parçalar / Parts

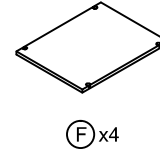

(F)x4

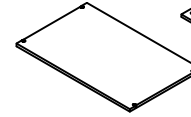

(E)x1

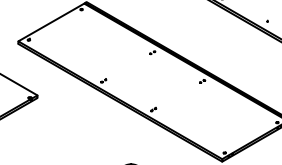

(C)x1

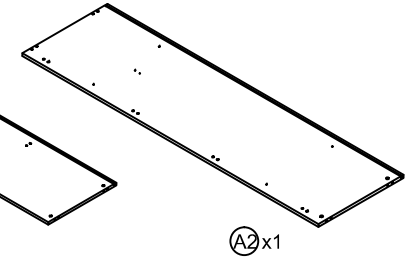

(A2)x1

Aksesuarlar / Hardware



(a)x 4



(b)x4



(d)x4

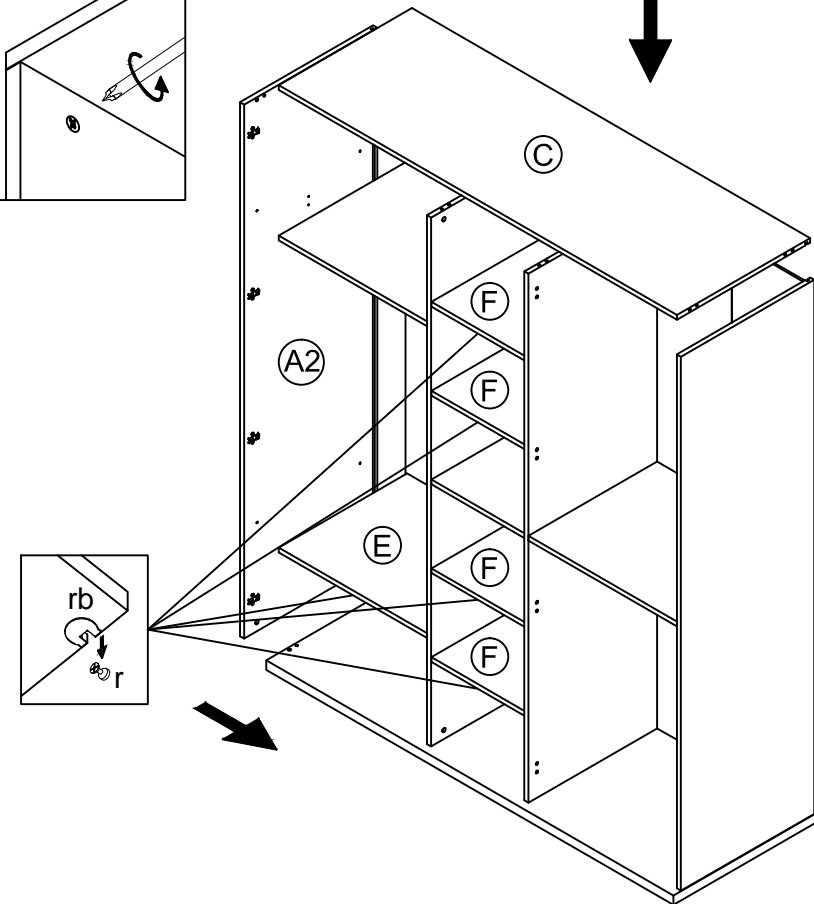
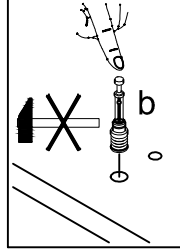
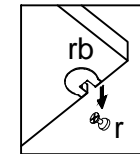
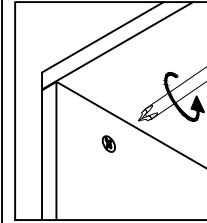

Adım / Step 5

Parçalar / Parts

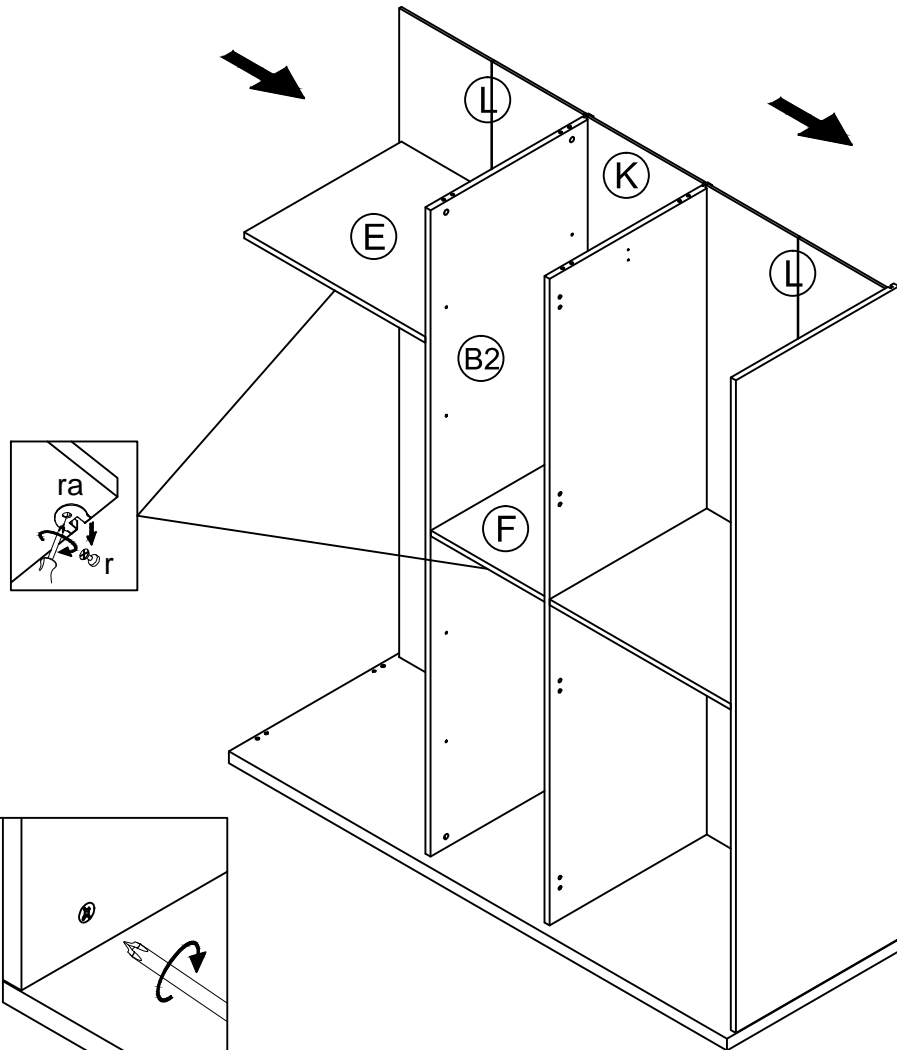
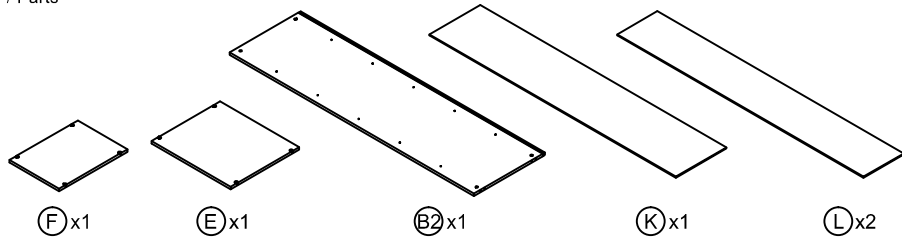

Adım / Step 2

Parçalar / Parts

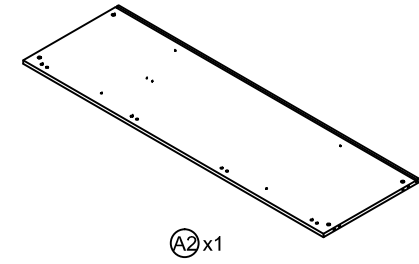

Aksesuarlar / Hardware

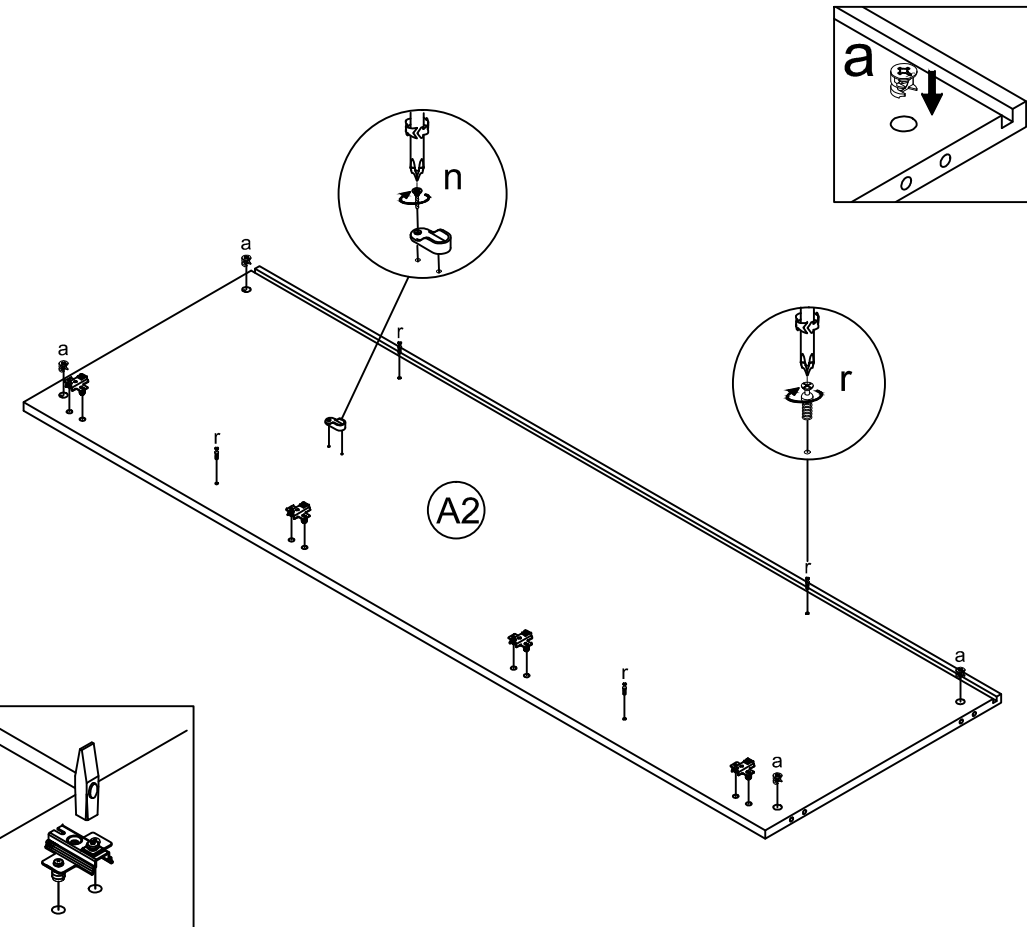
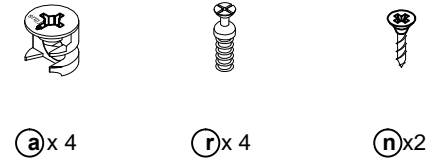

Adım / Step 3

Parçalar / Parts

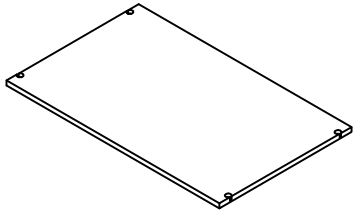

E x2

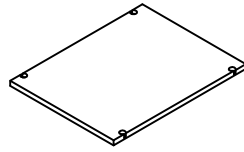

F x4

Aksesuarlar / Hardware



ra x8



rb x16

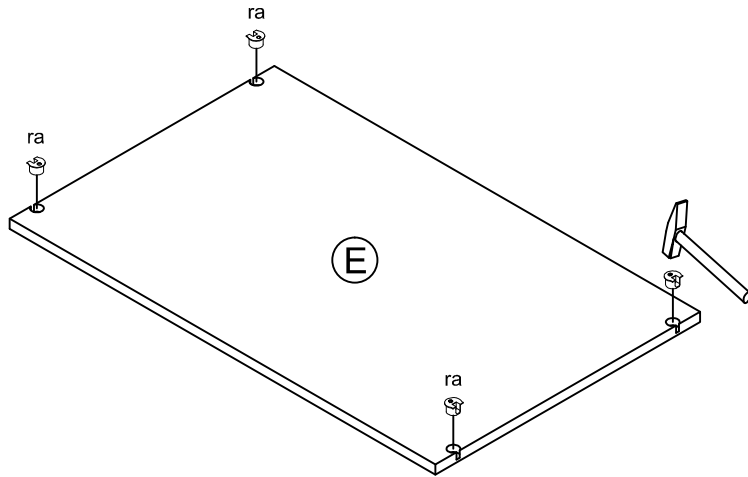
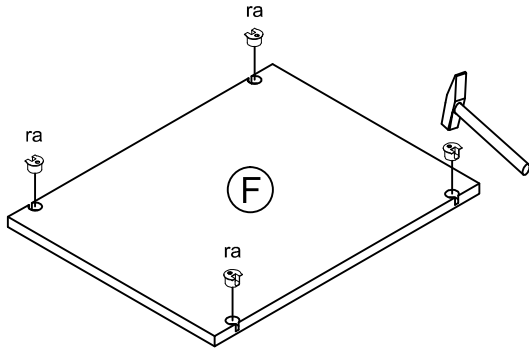

Adım / Step 4

Parçalar / Parts

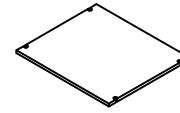

E x1

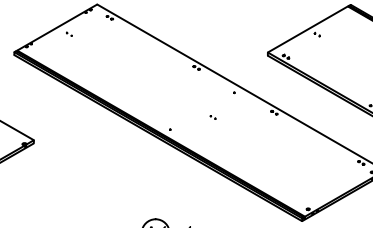

A1 x1

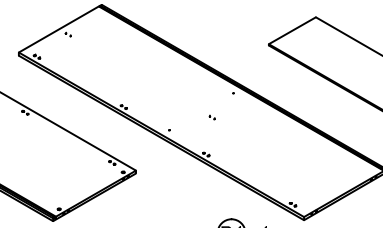

B1 x1

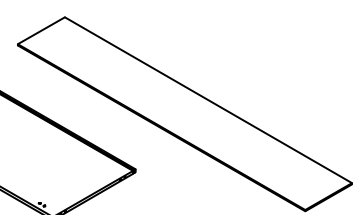

L x2

Aksesuarlar / Hardware



a x 8



r x20



n x2

